

Product Datasheet

3-port 10/100M Industrial PoE Fiber Switch

(ONV-IPS31032PF)



OVERVIEW

The ONV-IPS31032PF series is a 10/100M industrial PoE fiber switch independently developed by ONV. It has 2*10/100M PoE ports and 1*155M SC slot port, Port 1-2 can support IEEE 802.3af/at PoE standard, single port PoE power up to 30W, the maximum PoE output power is 36W (at-60W). As a PoE power supply device, it can automatically detect and recognize the power receiving equipment that meets the standard and supply power through the network cable. It can supply power to POE terminal equipment such as wireless AP, web camera, VoIP phone, industrial sensor through network cable, and meet the network environment that needs high-density PoE power supply. It is suitable for intelligent transportation, rail transit, electric power, mining, metallurgy and green energy. Industrial scenes such as construction set up a cost-effective and stable communication network.

Unmanaged model, plug and play, no configuration, easy to use.

FEATURE

■ 10/100M RJ45 and SC port, fast Ethernet

- ◇ All series supports "10/100M RJ45 port and 155M SC fiber port" combination, which enables users to flexibly build networking to meet the needs of various scenarios.
- ◇ Support non-blocking wire-speed forwarding.
- ◇ Support full-duplex based on IEEE802.3x and half-duplex based on backpressure.

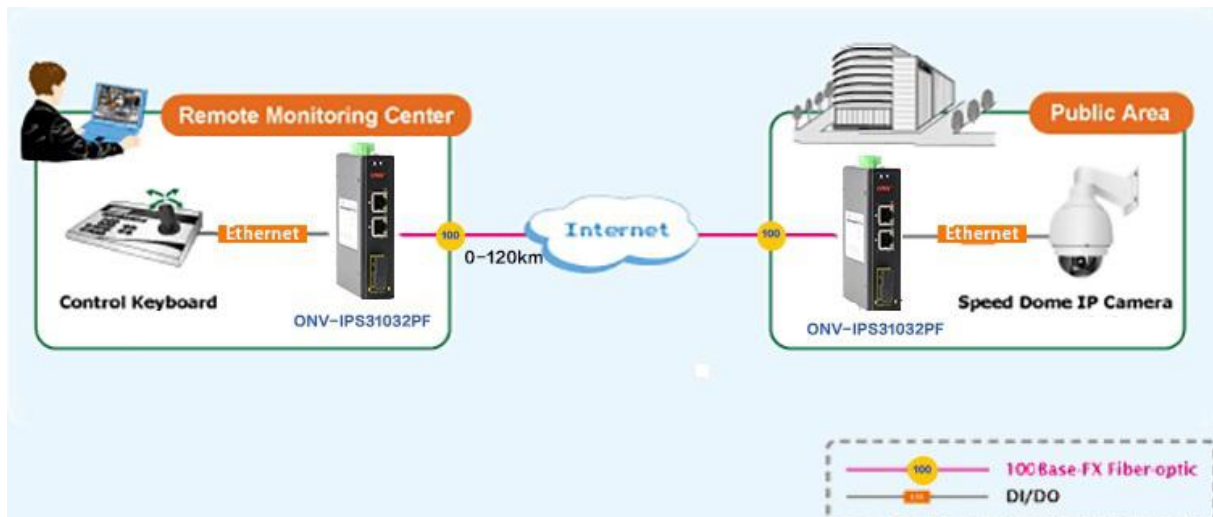

■ Port lightning protection, wide voltage input

- ◇ Contact discharge 8KV, air discharge 15KV; port lightning protection common-mode 4KV, differential mode 2KV;
- ◇ Industrial dual power input.
- ◇ DC INPUT: 48V-57V, non-PoE DC INPUT: 12-48V.

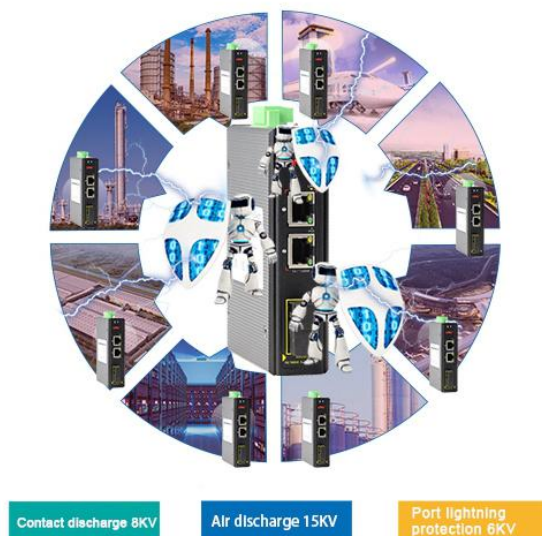

■ Intelligent PoE power supply

- ◇ 2*10/100Base-TX RJ45 ports support PoE power supply to meet the needs of PoE power supply in various scenarios in the industrial field.
- ◇ IEEE 802.3af/at PoE standard, without damaging non-PoE devices.
- ◇ Priority system for PoE port, it will supply power to the high priority level port first when the power budget is insufficient and avoid overwork of the device.

■ Stable and reliable

- ◇ Low power consumption, No fan, aluminum shell.
- ◇ CE, FCC, RoHS.
- ◇ The user-friendly panel, it can show the device status through the LED indicator of PWR, Link, PoE.

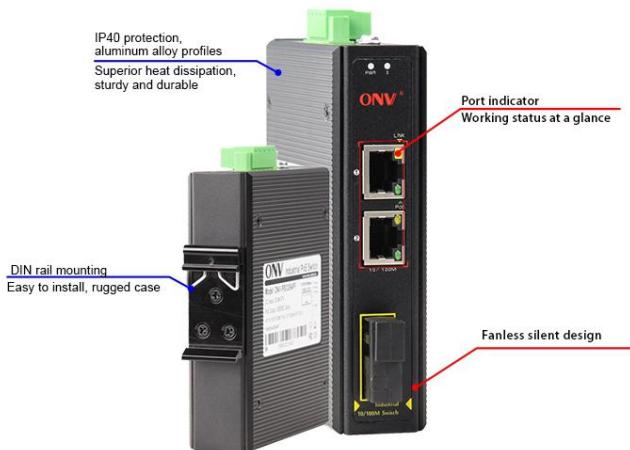

TECHNICAL SPECIFICATION

Model	ONV-IPS31032PF	ONV-IPS31032PF-at
Interface Characteristics		
Fixed Port	2*10/100Base-TX PoE ports (Data/Power) 1*155M uplink SC port (Data) 2 set of V+, V- redundant DC power interface (5 Pin Phoenix terminal)	
Twisted Pair	10BASE-T: Cat3,4,5 UTP(≤100 meter)	

Transmission	100BASE-T: Cat5e or later UTP(≤100 meter)	
Ethernet Port	10/100Base-TX, auto-sensing, Full/half duplex MDI/MDI-X self-adaption	
SFP Slot Port	The default optical module is single-mode dual-fiber 20km, SC interface.	
Optical Cable/ Distance	Multi mode: 850nm 0~500M; 1310nm 0~2kM; single mode: 1310nm 0~40KM,1550nm 0-120KM.	
Chip Parameter		
Network Protocol	IEEE802.3 10BASE-T, IEEE802.3i 10Base-T, IEEE802.3u 100Base-TX, IEEE802.3u 100Base-FX, IEEE802.3x	
Forwarding Mode	Store and Forward(Full Wire Speed)	
Switching Capacity	1.2Gbps	
Forwarding Rate@64byte	0.47Mpps	
MAC	1K	
Buffer Memory	768K	
Jumbo Frame	1536bytes	
LED Indicator	Powe: PWR (green), Network: Link (yellow), Fiber port : L/A (green) , PoE: PoE (green)	
PoE & Power		
PoE Port	Port 1-2	
Power Supply Pin	Default 1/2 (+), 3/6 (-) , optional 4/5 (+), 7/8 (-)	
Max Power Per Port	30W; IEEE802.3af/at	
Total PWR / Input Voltage	36W /48VDC	60W /48VDC
Power Consumption	Standby:<3W;Full load:<36W	Standby:<4W;Full load:<60W
Working Voltage	48-57VDC; 5 Pin industrial Phoenix terminal, support anti-reverse protection.	
Power Supply	No, optional 48V/36W or 48V/60W industrial power supply	

Physical Parameter	
Operation TEMP / Humidity	-40~+75°C;5%~90% RH Non condensing
Storage TEMP / Humidity	-40~+85°C;5%~95% RH Non condensing
Dimension (L*W*H)	119*100*30mm
Net /Gross Weight	<0.3kg / <0.6 kg
Installation	Desktop, DIN rail
Certification & Warranty	
Lightning protection / protection level	<p>Lightning protection: 6KV 8/20us; Protection level: IP40</p> <p>IEC61000-4-2(ESD):±8kV contact discharge,±15kV air discharge</p> <p>IEC61000-4-3(RS):10V/m(80~1000MHz)</p> <p>IEC61000-4-4(EFT): power cable:±4kV; data cable:±2kV</p> <p>IEC61000-4-5(Surge):power cable:CM±4kV/DM±2kV; data cable:±4kV</p> <p>IEC61000-4-6(radio frequency transmission):10V(150kHz~80MHz)</p> <p>IEC61000-4-8(power frequency magnetic field):100A/m;1000A/m ,1s to 3s</p> <p>IEC61000-4-9(pulsed magnet field):1000A/m</p> <p>IEC61000-4-10(damped oscillation):30A/m 1MHz</p> <p>IEC61000-4-12/18(shockwave):CM 2.5kV,DM 1kV</p> <p>IEC61000-4-16(common-mode transmission):30V; 300V,1s</p> <p>FCC Part 15/CISPR22(EN55022):Class A</p> <p>IEC61000-6-2(Common Industrial Standard)</p>
Mechanical Properties	IEC60068-2-6 (anti vibration), IEC60068-2-27 (anti shock)
	IEC60068-2-32 (free fall)
Certification	CCC;CE mark, commercial; CE/LVD EN60950;FCC Part 15 Class B; RoHS;
Warranty	5 years, lifelong maintenance.

DIMENSION

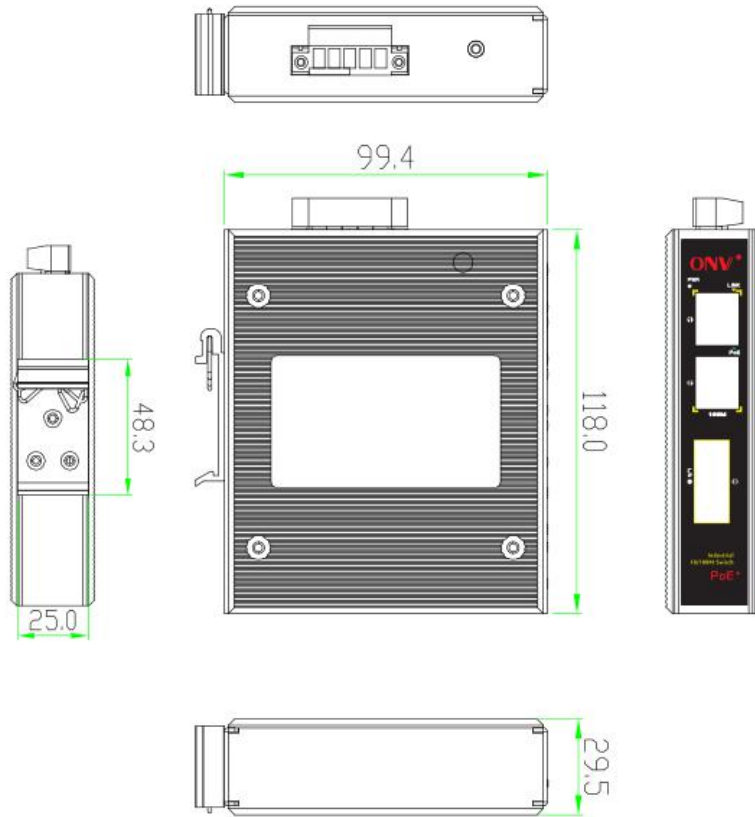

APPLICATION

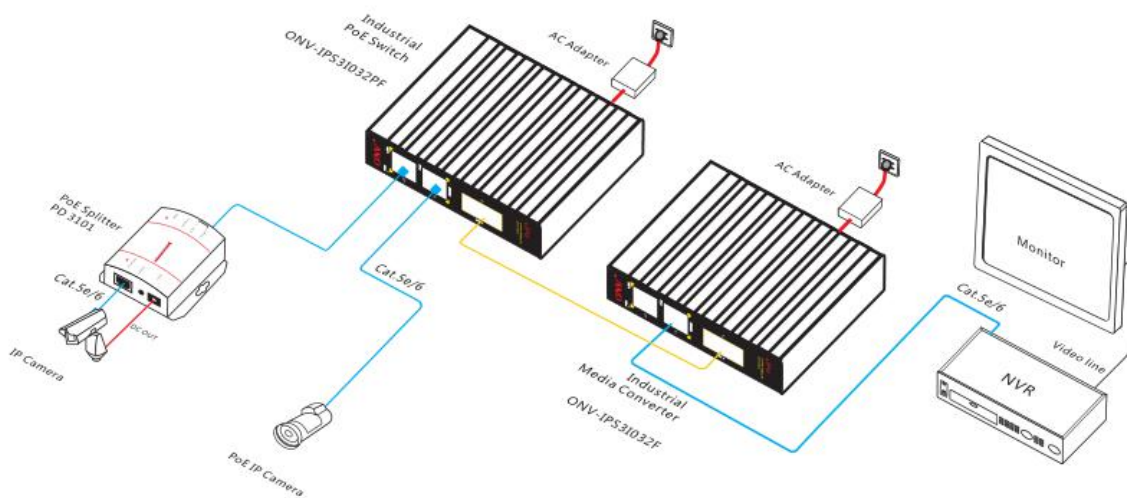

ORDERING INFORMATION

Model	Description	Recommended Power Supply
ONV-IPS31032PF	Unmanaged industrial PoE fiber switch with 2*10/100M PoE port and 1*155M SC port, Port 1 can support PoE IEEE802.3af/at. By default, the SC port 1310nm/20km single-mode dual-fiber module. It can support dual DC redundant power input (Phoenix terminal connection) and DIN rail mounting.	36W
ONV-IPS31032PF-at		60W
ONV-IPS31032PF-M	Unmanaged industrial PoE fiber switch with 2*10/100M PoE port and 1*155M SC port, Port 1 can support PoE IEEE802.3af/at. By default, the SC port 850nm/0.5km or 1310nm/2km multi-mode dual fiber module. It can support dual DC redundant power input (Phoenix terminal connection) and DIN rail mounting.	36W
ONV-IPS31032PF-M-at		60W
ONV-IPS31032PF-A	Unmanaged industrial PoE fiber switch with 2*10/100M PoE port and 1*155M uplink SC port . Port 1 can support IEEE 802.3af/at. By default, the SC port 1310nm/20km single-mode single-fiber module. It can support dual DC redundant power input (Phoenix terminal connection) and DIN rail mounting.	36W
ONV-IPS31032PF-A-at		60W
ONV-IPS31032PF-B	Unmanaged industrial PoE fiber switch with 2*10/100M PoE port and 1*155M uplink SC port . Port 1 can support IEEE 802.3af/at. By default, the SC port 1550nm/20km single-mode single-fiber module. It can support dual DC redundant power input (Phoenix terminal connection) and DIN rail mounting.	36W
ONV-IPS31032PF-B-at		60W

Note: Industrial PoE switch does not match the power supply .

PACKING LIST

PACKING LIST	CONTENT	QTY	UNIT
	3-port 10/100M industrial PoE fiber switch	1	SET
	User Guide	1	PC
	Warranty Card	1	PC

POWER SUPPLY SELECTION TABLE

Product	Model	Description	Unit
36W Desktop Power Adaptor	GWS-AP36-52	Desktop tape 36W single set of output power adapter; Input Voltage:AC 100V~240V 50-60Hz,0.56A Output Voltage:DC 52V 0.7A Operation Temperature:-20℃—+65℃	PC
65W Desktop Power Adaptor	GWS-AP65-52	Desktop tape 65W single set of output power adapter; Input Voltage:AC 100V~240V 50-60Hz,1.1A Output Voltage:DC 52V 1.25A Operation Temperature:-20℃—+65℃	PC
36W DIN Rail Industrial Power Supply	GWS-DP36-48	Din Rail type 36W single set of output power supply; Input Voltage:AC 100V~240V 50-60Hz, 0.56A	PC

		Output Voltage:DC 24V 0.75A Operation Temperature:-40℃—+70℃	
60W DIN Rail Industrial Power Supply	GWS-DP60-48	Din Rail type 60W single set of output power supply; Input Voltage:AC 100V~240V 50-60Hz,1A Output Voltage:DC 48V 1.25A Operation Temperature:-40℃—+70℃	PC

RELATED PRODUCT

Model	Description
ONV-IPS31021PF	Unmanaged industrial PoE fiber switch with 1*10/100M RJ45 port and 1*155M SC port, Port 1-2 can support PoE IEEE802.3af/at. By default, the SC port 1310nm/20km single-mode dual-fiber module. It can support dual DC redundant power input (Phoenix terminal connection) and DIN rail mounting.
ONV-IPS31004PF	Unmanaged industrial PoE fiber switch with 4*10/100M RJ45 ports and 1*155M SC port, Port 1-4 can support PoE IEEE802.3af/at. By default, the SC port 1310nm/20km single-mode dual-fiber module. It can support dual DC redundant power input (Phoenix terminal connection) and DIN rail mounting.
ONV-IPS31064PF	Unmanaged industrial PoE fiber switch with 4*10/100M RJ45 ports and 2*155M SC ports, Port 1-4 can support PoE IEEE802.3af/at. It can support DC dual redundant power input and DIN rail mounting.
ONV-IPS31084PF	Unmanaged industrial PoE fiber switch with 4*10/100M RJ45 ports and 1*155M SC port, Port 1-4 can support PoE IEEE802.3af/at. By default,

	the SC port 1310nm/20km single-mode dual-fiber module. It can support dual DC redundant power input (Phoenix terminal connection) and DIN rail mounting.
ONV-IPS31108PFB	Unmanaged industrial PoE fiber switch with 8*10/100M PoE ports and 2*10/100/1000M RJ45 ports and 2*1000M SFP slot ports (combo port), Port 1-8 can support PoE IEEE802.3af/at. It can support DC dual redundant power input and DIN rail mounting.

CONTACT US



OPTICAL NETWORK VIDEO TECHNOLOGIES (SHENZHEN) CO., LTD.

Tel: 0086-755-33376606

Fax: 0086-755-33376608

Email: onv@onv.com.cn

Website: www.onvcom.com

Zip: 518000

Headquarter Address: Room 1003, Block D, Terra Building, Futian District, Shenzhen, China

Factory Address: The 4-6th Floor, No. 59, HuaNing Road, Xinwei Community, Dalang Street,

Longhua District, Shenzhen, China

